

Article number: 2307030511

Description: E+G Solid handwheel
VDC.125-GXX2+I

Measures

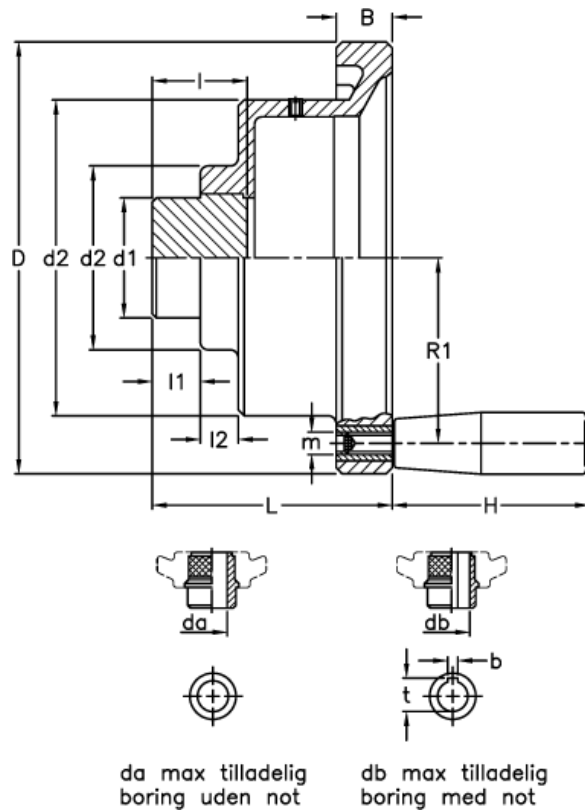

b = 6	H = 65
B = 16	l = 25
D = 125	L = 61
d1 = 30	l1 = 12
d2 = 48	l2 = 9.0
d3 = 82	m = M8
da = 25	R1 = 53.0
db = 20	t = 22.8